



## ARREDO URBANO FONTANE

**RCL**  
COSTRUIRE PER IL VERDE

# ARREDO URBANO



LA PANCA CON SCHIENALE ART. 83

La PANCA da arredo urbano:  
ROBUSTA, COMPONIBILE,  
ASSAI RESISTENTE PER PESO (kg. 120)  
E CONFIGURAZIONE, AD ATTI DI VANDALISMO  
E' composta da moduli seduta da 50 cm.  
(sp. cm. 20 - prof. cm. 60)  
in calcestruzzo serizzo e rosa.

## PANCHINE



LA PANCA SENZA SCHIENALE ART. 84



REALIZZAZIONE IN CASSANO D'ADDA (MI)



PANCHINA CLASSICA ART. 88



PANCA IROKO CON SCHIENALE ART. 82



PANCA IROKO SENZA SCHIENALE ART.81



# SIESTA

Realizzazione in Recco (GE)



Schema degli elementi e loro componibilita'

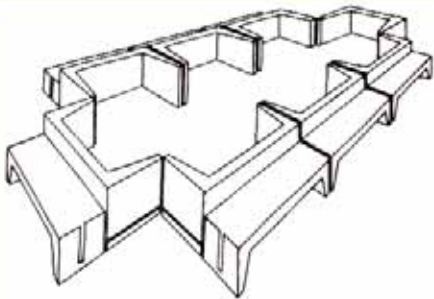

BLOCCO SIESTA ART. 90

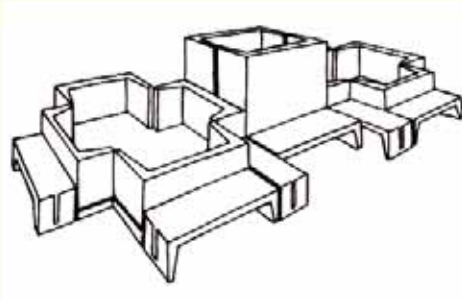

BLOCCO SPECIAL ART. 91

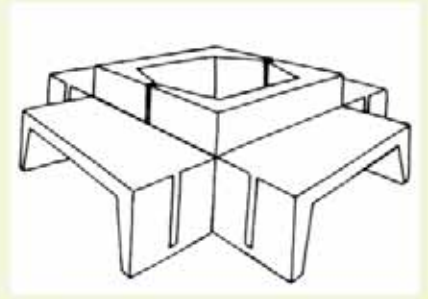

BASAMENTO ART. 92

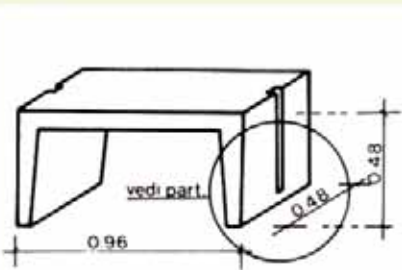

FIORIERA PICCOLA ART. 94

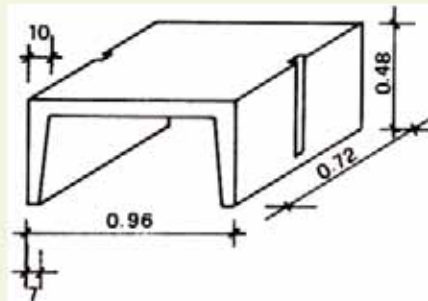

FIORIERA GRANDE ART. 95

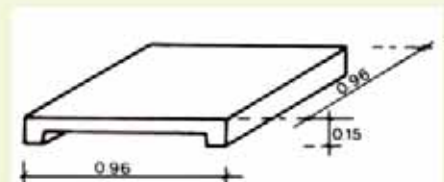

Il mezzo basamento  
ha le dimensioni di m. 0,96 x 0,48

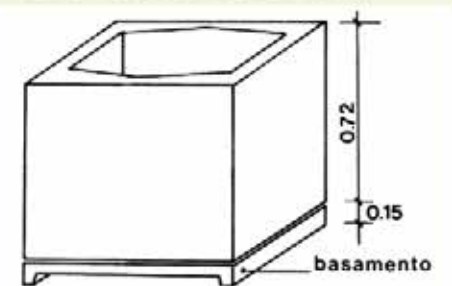
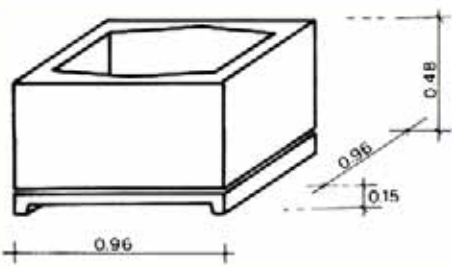

# PORTARIFIUTI



## PORTARIFIUTI DA CITTA'

per qualsiasi ARREDO URBANO, di facile inserimento in ambienti moderni e Centri Storici. La pannellatura posta sui due lati, permette la personalizzazione, nonché la possibilità di avere spazi pubblicitari per DITTE, AZIENDE, NEGOZI, ecc.

ART. 99

Il PORTARIFIUTI della linea R.C.L. è costituito da elementi in CALCESTRUZZO GRIGIO e COLORATO, completo di fondo ed una struttura in lamiera, brunture canna di fucile, comprendente un telaio portasacco ed un coperchio munito di chiusura, per accesso al solo operatore per lo svuotamento e la sostituzione del sacco.

DATI TECNICI:	DIMENSIONE (in pianta)	cm. 60x60
	ALTEZZA TOTALE	cm. 110
	CAPACITA'	litri 130
	PESO	kg. 200 circa



# METABICI

DIMENSIONI: cm. 75x31 h. 37,5  
PESO: kg. 90 circa  
COLORI: Bianco e Grigio



# BLOCCAUTO

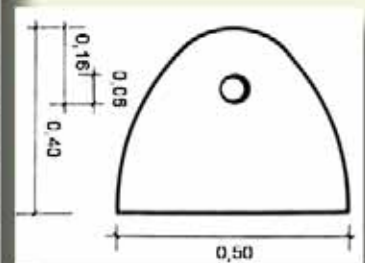

DISSUASORE DI SOSTA PESO kg 110 circa

# ARTICOLI VARI



PORTABICI ART. 287



CUCCE PER CANI  
ART. 271 cm. 100x80 h102  
ART. 272 cm. 80x60 h 81



PORTABICI ART. 264/1 GRIGIO



PORTABICI ART. 264/2



VASCA LAVATOIO ART.276  
CON ASSE LEVIGATO SENZA DIVISORIO



TAVOLO RETTANGOLARE ART. 261  
completo di 2 panche senza schienale  
cm 180 x 80 h70



PORTAOMBRELLONI ART.263

# FONTANE

## LINEA MARTELLINATA

### Le FINITURE



SERIZZO ROSSO

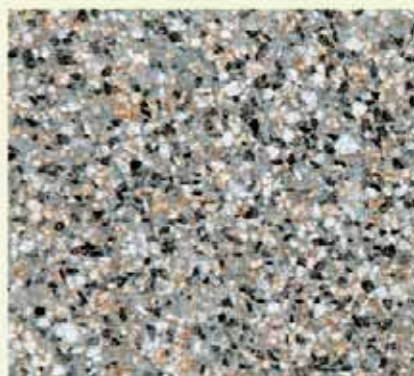

SERIZZO



GRANITO



ART.250 "PRIMULA"  
52x34 h120 Kg.55



ART.251 "ROSA"  
44x35 h116 Kg.101



ART.252 "ORCHIDEA"  
50x40 h130 Kg.97



ART.253 "ANEMONE"  
80x40 h127 Kg.140



ART.254 "GIGLIO"  
64x38 h141 Kg.112



ART.255 "VIOLA"  
46x55 h114 Kg.126



ART.256/A "GIRASOLE ALTA"  
Ø 60 h121 Kg.162



ART.256/M "GIRASOLE MEDIA"  
Ø60 h88 Kg.140



ART.257 "GERANIO"  
44x51 h98Kg 96



ART.258 "PETUNIA"  
Ø 50 h95 Kg.64



ART.290 "MORTAIO"  
Ø65 h42 Kg.154



ART.291 "ROMANA"  
Ø 54 h70 Kg.124



ART.292 "CAMELIA"  
38x57 h90 Kg.61



ART.297 sporgenza cm.16



ART.293 "DALIA"  
55x65 h118 Kg.175



ART.294 "TULIPANO"  
40x50 h98 Kg.80

# FONTANE

## LINEA ANTICATA

Le FINITURE



ANTICATA BIANCA



ANTICATA GIALLA



ANTICATA ROSA



ART.251 "ROSA"  
44x35 h116 Kg 101



ART.252 "ORCHIDEA"  
50x40 h130 Kg.97



ART.254 "GIGLIO"  
64x38 h141 Kg.112



ART.255 "VIOLA"  
46x55 h114 Kg.126



ART.256/A "GIRASOLE ALTA"  
Ø 60 h121 Kg.162



ART.299 sporgenza cm.16



ART.256/M "GIRASOLE MEDIA"  
Ø 60 h88 Kg.140



ART.257 "GERANIO"  
44x51 h98 Kg.96



ART.258 "PETUNIA"  
Ø 50 h95 Kg.64



ART.290 "MORTAIO"  
Ø 65 h42 Kg.154



ART.291 "ROMANA"  
Ø 54 h70 Kg.124



ART.292 "CAMELIA"  
38x57 h90 Kg.61



ART.293 "DALIA"  
55x85 h118 Kg.175



ART.294 "TULIPANO"  
40x50 h98 Kg.80



ART.298  
sporgenza cm.20 h cm.46



ART.295 "FIORE"  
base 35x35 h90 Kg.45



ART.296 "CICLAMINO"  
32x56 h140 Kg.109



# RCL

Via del Fabricone 11 24060 GORLAGO (BG)  
Tel. 035 4251241 Fax 035 4251242  
[rcldomino.it](http://rcldomino.it) [rcl@rcldomino.it](mailto:rcl@rcldomino.it)